

Trident T676307
Utility Dolly

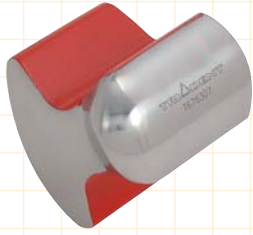

Trident T676309
Ring Dolly - Large



Trident T676308
Ring Dolly - Small



Trident T676301
Angle Dolly



Trident T676302
Curved Dolly



Trident T676303
Heel Dolly



Trident T676304
Toe Dolly



Trident T676306
Thin Toe Dolly



Trident T676305
Body Spoon



Trident T676201
Panel Hammer
Flat Face Bumping



Trident T676202
Panel Hammer
Shrinking



Trident T676203
Panel Hammer
Spiral Faced
Shrinking



Trident T676208
Replacement Hickory Shaft
with Wedge available.

Trident T676204
Panel Hammer
Curved Pein
Finishing



Trident T676205
Panel Hammer
Straight Pein
Finishing



Trident T676206
Panel Hammer
Pick and Finishing

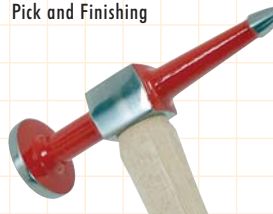

Trident T676207
Panel Hammer
Bumping
Crown Face

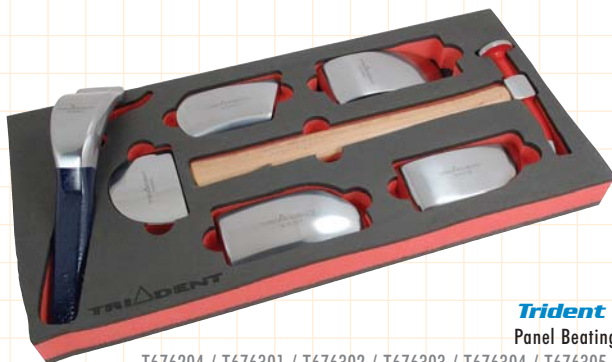

Trident T676352
Panel Beating Set - 7pc
T676204 / T676301 / T676302 / T676303 / T676304 / T676305 / T676306



Trident T676351
Panel Beating Set - 4pc
T676205 / T676207 / T676303 / T676304



Trident T254204
Hammer - 4oz Ball Pein



Signet

**Ball Pein Hammers
Glass Fibre Shafts**

S80141	8oz
S80146	16oz
S80150	24oz
S80155	32oz
S80160	40oz

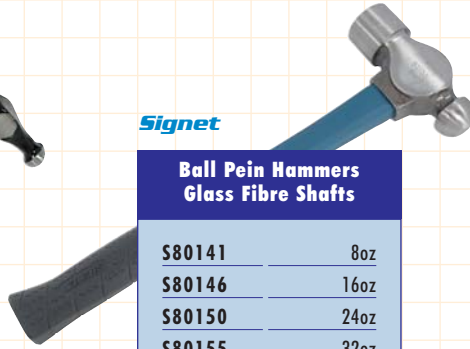

**Steel Bench Vice
with Swivel Base**

T681104	4" Jaws
T681105	5" Jaws
T681106	6" Jaws

Trident

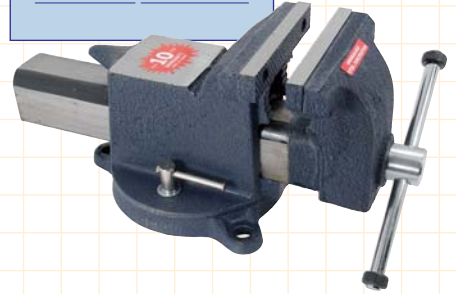

Normex N138
Club Hammer
1.5Kg

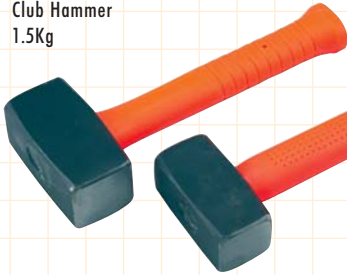

Normex N136
Club Hammer
1Kg

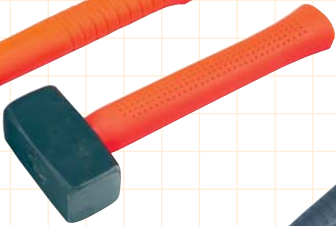

Signet

**Shockless / Deadblow
Hammers**

S80451	NBR 1lb
S80452	NBR 1.5lb
S80453	NBR 2lb
S80454	NBR 2.5lb
S80455	NBR 3lb



Thor TH212
Copper Hide Hammer
No2 1070g



Thor TH214
Copper Hide Hammer
No3 1650g



Thor TH712
Nylon Faced Hammer
675g



Thor TH5704
Copper Hammer
930g



Thor TH954
Rubber Mallet
Non-Marking
750g



Trident T254103
Sledge Hammer - 3lb
16" Fibreglass Handle



Trident T254104
Sledge Hammer - 4lb
16" Fibreglass Handle



Trident T674112
Slide Hammer Set
(Knocker Set) 12lb

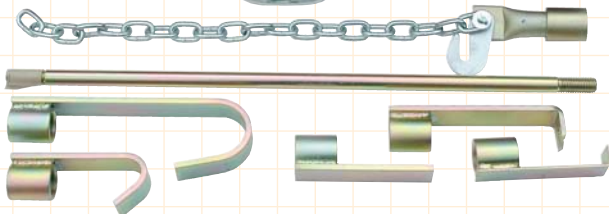

Signet S80224
Rubber Mallet - 680g



Trident T252300
Long Punch Set - 4pc
350mm Long
10 - 16mm



Mayhew MA106K
Pilot Punch- 6pc set
1/8" - 5/16"



Mayhew MA446K
Punch Set - 5pc
1/8" - 3/8"
Extra Long



Mayhew Pilot Punches

MA112-1/8	1/8"
MA112-5/32	5/32"
MA112-3/16	3/16"
MA112-7/32	7/32"
MA112-1/4	1/4"

Mayhew Long Punches

MA443-1/8	1/8"
MA443-5/32	5/32"
MA443-3/16	3/16"
MA443-7/32	7/32"
MA443-1/4	1/4"

Trident T252200
Pin Punch Set - 6 piece
200mm long
2 - 8mm



Mayhew MA125K
Punch Line-Up Set - 4pc
1/8" - 1/4"



Mayhew MA4101K
Pin Punch Set - 6pc
Metric 3 - 8mm



Trident T252100
Pin Punch Set - 6pc
2 - 8mm



Mayhew Line-up Punches

MA466-1/8	1/8"
MA466-5/32	5/32"
MA467-3/16	3/16"
MA460-1/4	1/4"

Mayhew Pin Punches

MA413-3	3mm
MA413-4	4mm
MA413-5	5mm
MA413-6	6mm
MA413-7	7mm
MA413-8	8mm

Mayhew Centre Punches

MA415-1/4	1/4"
MA415-5/16	5/16"
MA415-3/8	3/8"
MA416-1/2	1/2"



Proto Pin Punches

471/4X1/16	1/16"
471/4X3/32	3/32"
475/16X1/8	1/8"
475/16X5/32	5/32"
473/8X3/16	3/16"
477/16X7/32	7/32"
471/2X1/4	1/4"

Proto 47A
Pin Punch Set - 7pc
1/16" - 1/4"



Proto 48005L
Pin Punch Set - 5pc
5/32" - 5/16"
Long



Proto 48007
Pin Punch Set - 7pc
1/16" - 1/4"
Super Duty



Proto 47B
Pin Punch Set - 5pc
1/8" - 1/4"



Proto 96A
Drift Punch Set - 7pc
3/32" - 3/8"



Proto 96B
Drift Punch Set - 5pc
1/8" - 5/16"



Proto Drift Punches

961/4	3/32"
965/16	1/8"
963/8	3/16"
967/16	7/32"
961/2	1/4"
965/8	5/16"
963/4	3/8"

8



Trident T252500
Centre Punch - Automatic
no hammer required

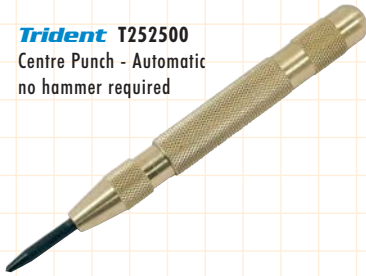

Trident T253200
Alpha Numeric Punches - 36pc set
with 4mm Letters A - Z
Numbers 0 - 9



Trident T252400
Brass Drifts - 5pc set
Supplied in a vinyl wallet

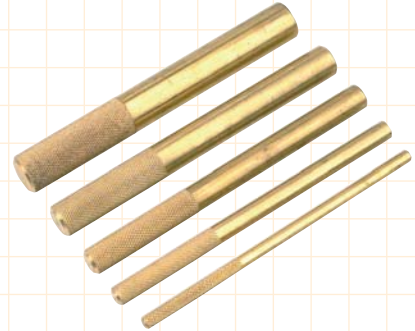

Lisle L3028
Centre Punch - Automatic
adjustable pressure



Signet S60501
Pin Punch Set - 6pc
Metric 2 - 6mm
Polished Chrome



Signet S60571
Centre Punch
1 x 100mm

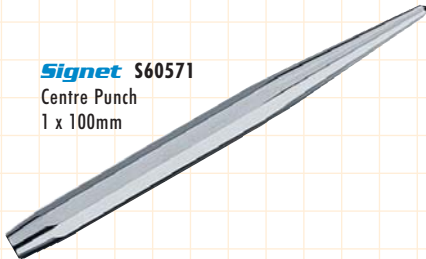

Signet S60572
Centre Punch
2 x 120mm

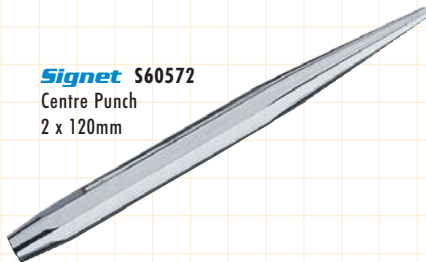

Mayhew MA7014K
Punch and Chisel Set - 14pc

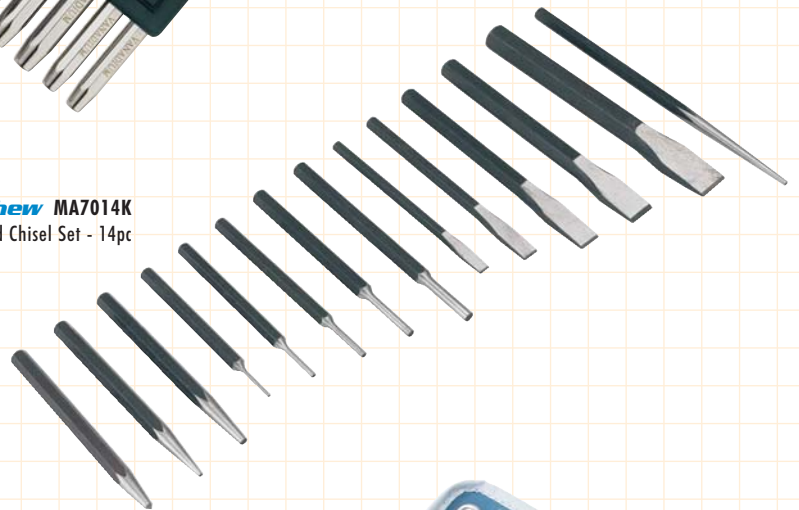

Trident T253100
Punch and Chisel Set - 16pc Carbon Steel budget set



Mayhew MA751K
Punch and Chisel Set - 6pc



Proto 86B
Chisel Set - 7pc
5/16" - 7/8"

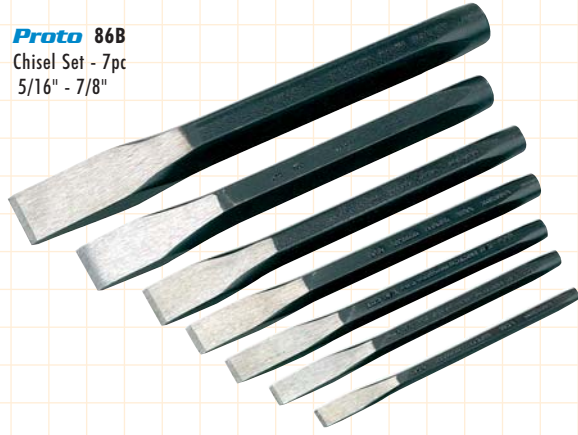

Proto 86C
Chisel Set - 5pc
5/16" - 5/8"



Trident T251100
Chisel Set - 5pc
10, 12, 16, 19, 22mm



Mayhew MA7001K
Chisel Set 6pc
1/4" - 3/4"



Mayhew Chisels

MA70-1/4	1/4"
MA70-5/16	5/16"
MA70-3/8	3/8"
MA70-7/16	7/16"
MA70-1/2	1/2"
MA70-5/8	5/8"
MA70-3/4	3/4"
MA70-7/8	7/8"
MA70-1	1"

Lisle L5190
Spot Weld Chisel



Trident T251200
Chisel Set Ribbed - 4pc
16, 19, 24, 28mm



Trident Ribbed Chisels

T251201	16 x 125mm
T251202	19 x 150mm
T251203	24 x 200mm
T251204	28 x 250mm

Trident ZBIF
Spot Weld Chisel

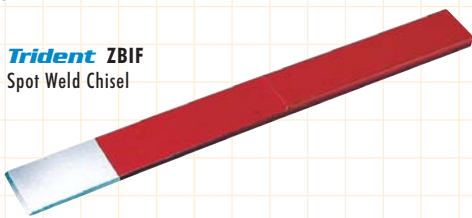

Trident ZBIH
Chisel - Side Cutting
for panels

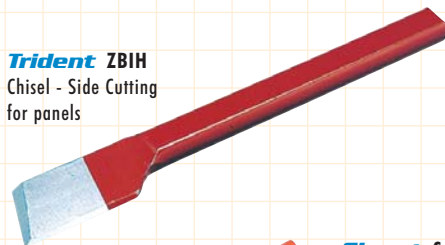

Signet S46704
Chisels - 4pc set
Plastic

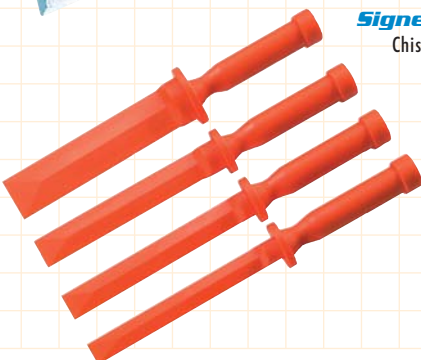

Mayhew 12" Chisels

MA110-1/2	1/2"
MA110-3/4	3/4"
MA110-7/8	7/8"
MA110-1	1"



Mayhew MA481
Pry Bar - 9" Roll Head



Mayhew MA482
Pry Bar - 16" Roll Head

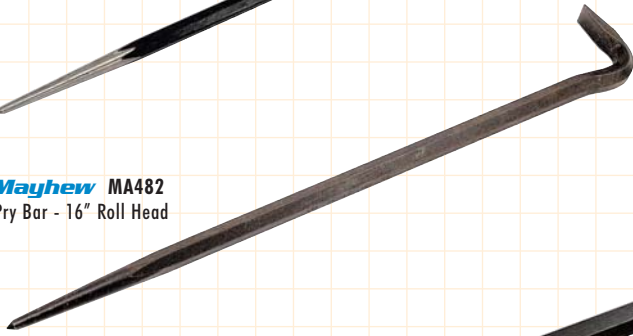

Mayhew MA483
Pry Bar - 18" Roll Head

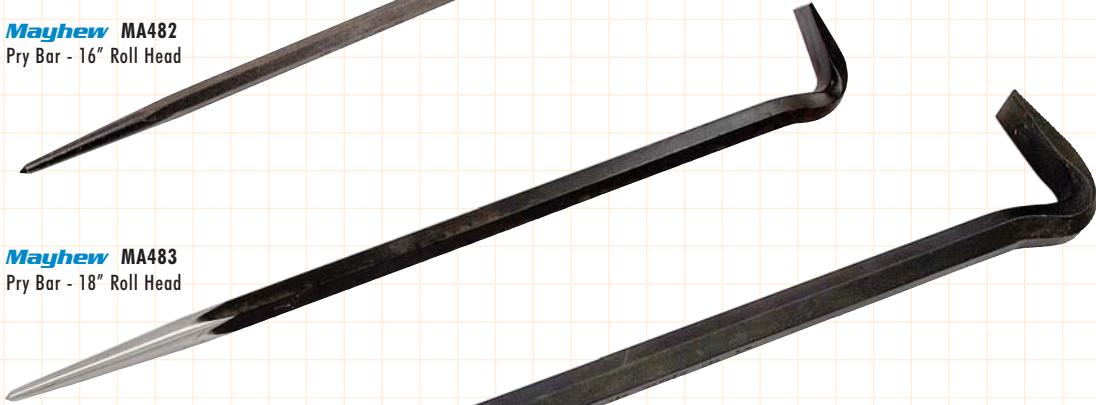

Mayhew MA484
Pry Bar - 22" Roll Head



Mayhew MA60150
Pry Bars - 3pc set 12" 16" 21"
Lady Foot

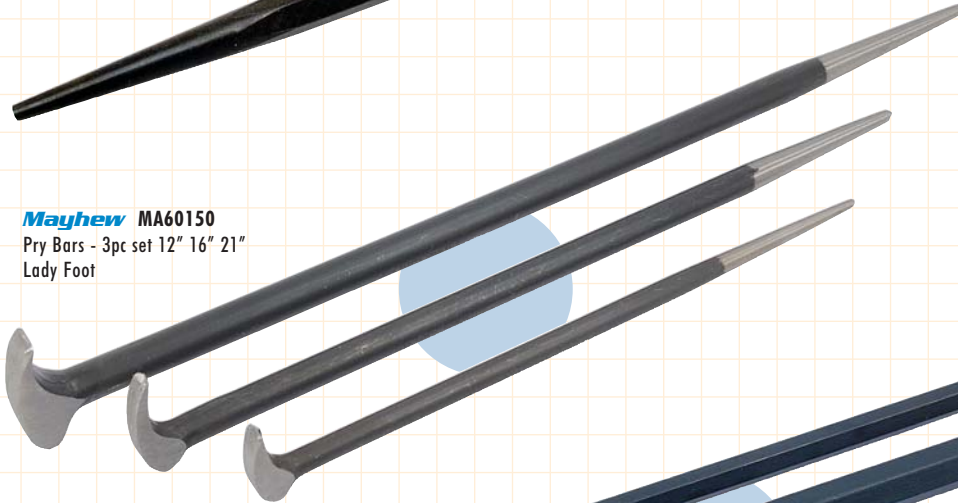

Mayhew MA61306
Pry Bars - 3pc set
Rolling Head - 16"
Line-Up - 14" and 20"

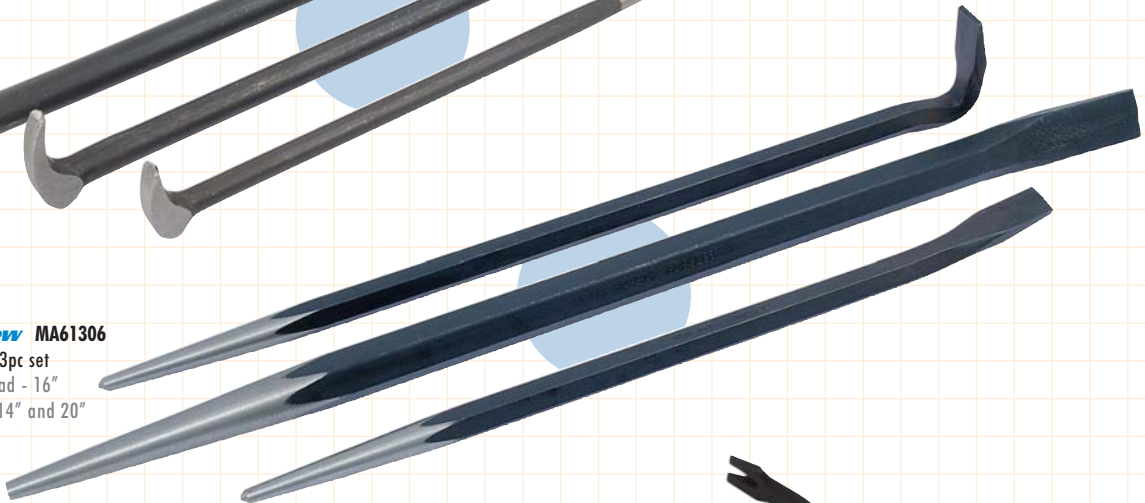

Mayhew MA710
Wrecking Bar - 24"

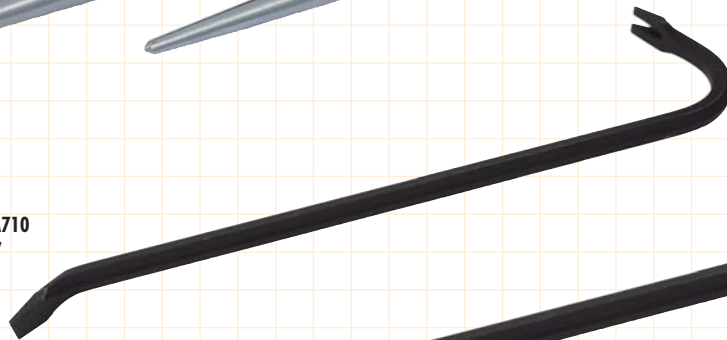

Mayhew MA717
Wrecking Bar - 36"

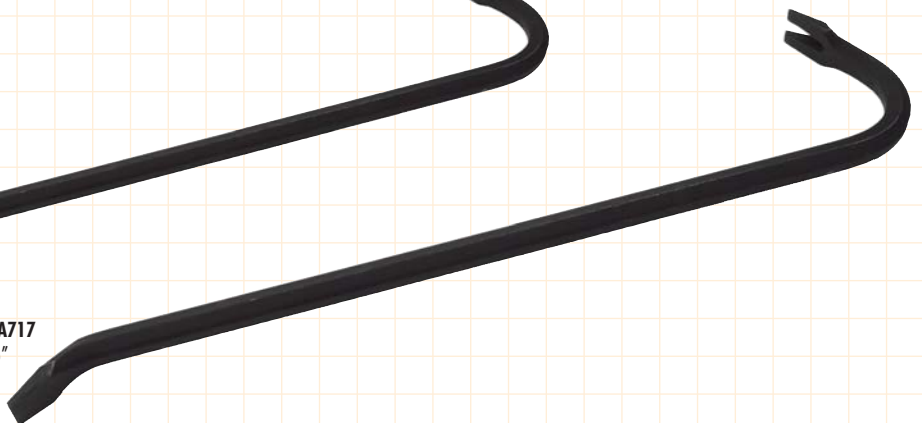

Trident TPBSET
Pry Bar - 4pc set Heavy Duty
Bar extends through handle

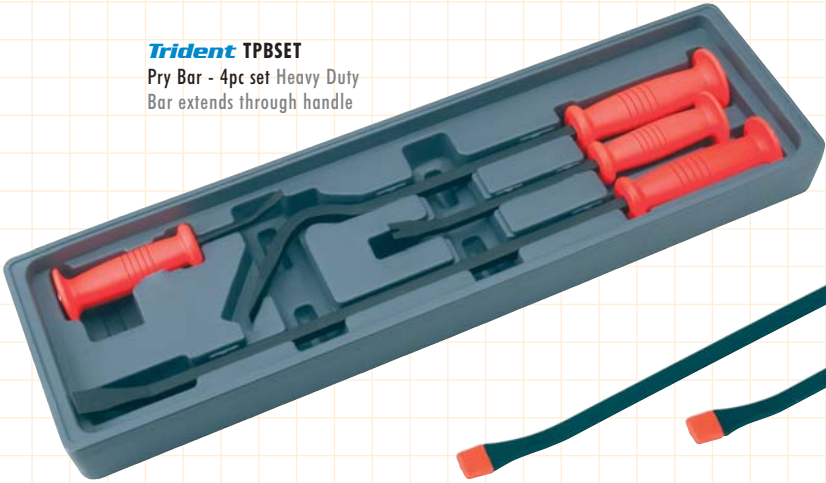

Signet S46224
Pry Bar Set - 4pc
8" 12" 18" 24"
Hi-vis Handles

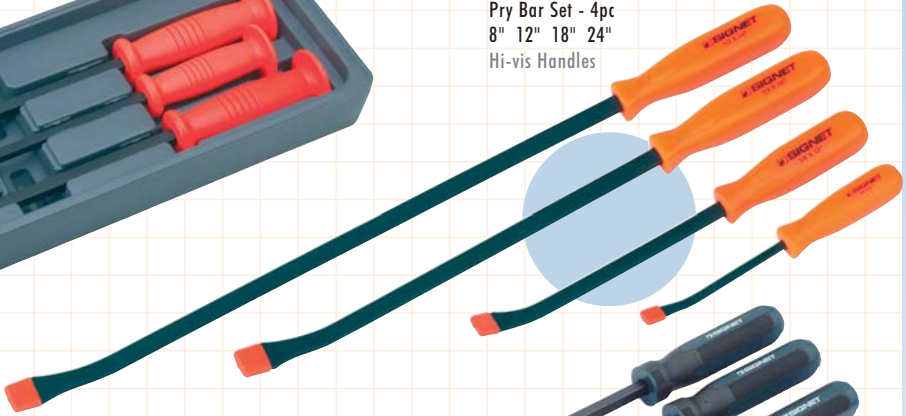

Mayhew

Dominator Pry Bars	
MA60140	12"
MA60144	17"
MA60146	25"
MA60148	31"
MA40138	36"
MA40139	42"
MA40160	48"
MA40162	58"

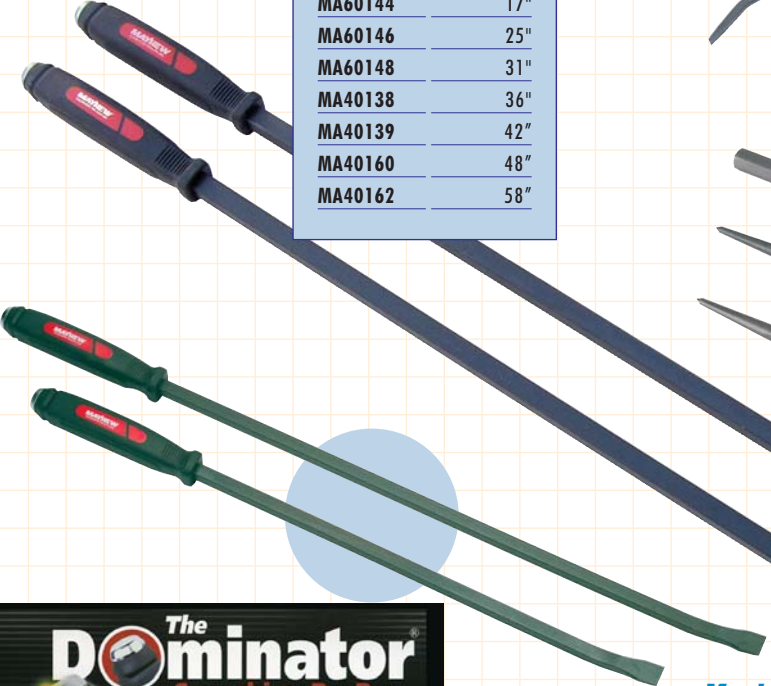

Signet S46226
Pry Bar Set - 4pc
Pound Through
8" . 12" . 18" . 24"

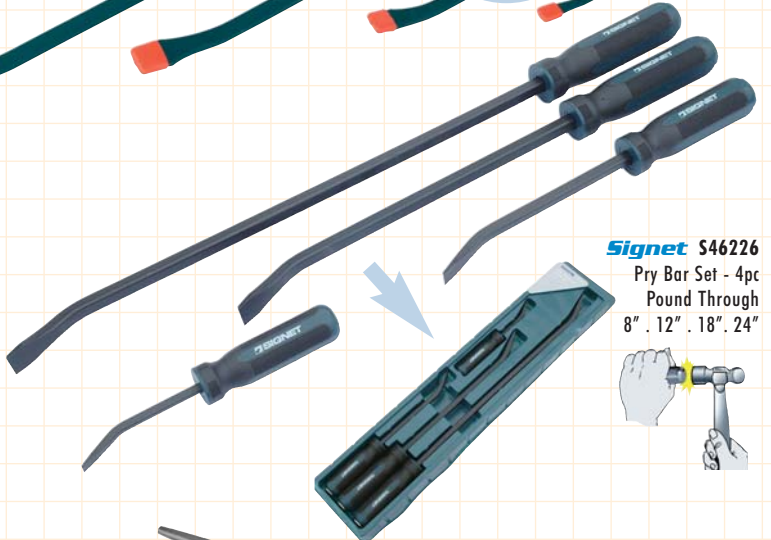

Mayhew MA76284
Line-Up Bars - 4pc set
Line-up - 14"
Line-up - 20"
Cold Chisel 7/8" x 18"
Rolling Head - 16"

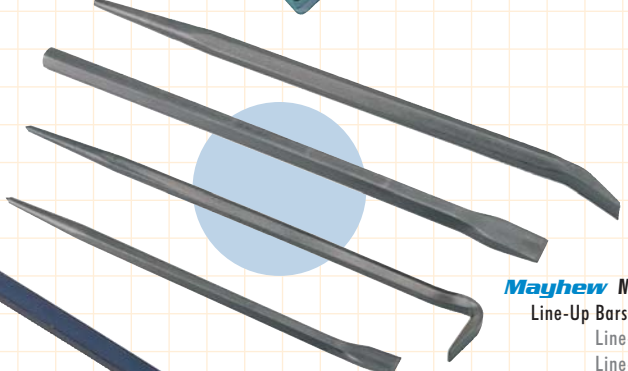

Mayhew MA61353
Dominator Pry Bars
2pc set 25" and 31"

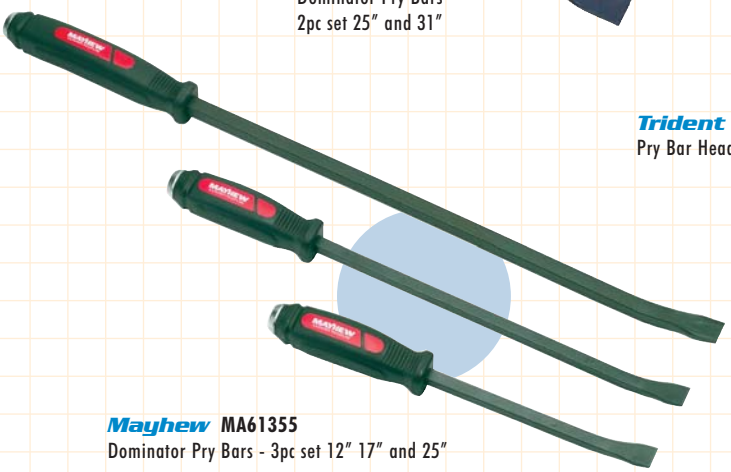

Trident T261100
Pry Bar Head - 3/8"Dr



Mayhew MA61355
Dominator Pry Bars - 3pc set 12" 17" and 25"

The Dominator
Screwdriver Pry Bar

Available in several sizes:
 10 inch bar (curved only) 31 inch bar (curved & straight)
 12 inch bar (curved & straight) 36 inch bar (curved only)
 17 inch bar (curved & straight) 42 inch bar (curved only)
 25 inch bar (curved & straight)

FULL WARRANTY
from tip to tip

Capped end allows user to strike the pry bar without handle damage

Capped end in direct contact with shaft

Shaft goes through handle for prying power

Hardened and tempered the entire length for maximum durability

Patented Two composite, ergonomically designed handle provides comfortable & secure grip

U.S. Patent No. 6,471,186

Available in both curved and straight blades

MAYHEW TOOLS